

# option 3

## Framed Fence Extension Installation Instructions

- Tools**
- Power drill
  - 4mm drill bit
  - 9mm drill bit
  - Pliers
  - Marking pen
  - Wood saw
  - Phillips screwdriver
  - Hacksaw\*
- \*required only if reducing the length of the fence extension
- Frame Kit contents: (sold separately)**
- One (1) long channel (2382mm)
  - Two (2) short channels (1500mm)
  - Two (2) plastic corners
  - Eight (8) plastic screw hole caps
  - One (1) centre bracket

NOTE: For each EcoScreen Fence Extension Panel you will need to purchase one (1) Frame Kit and the following hardware:

- Three (3) centre bracket screws
- Four (4) mounting screws (maximum head diameter 9mm)
- Four (4) screws OR rivets for corners

- Preparation**
- 1 Clear a work area where you can assemble the frame to the panel.
  - 2 Ensure that the fence is solid and secure. Check the line of the top of the fence. If this line is not horizontal, you can install the fence extensions as shown in Fig. 1A. If this line is not straight, you can step the fence extensions to suit as shown in Fig. 1B.
  - 3 There is a large flange on one edge of the Fence Extension Panel and a small flange on the other edge. Using a saw cut 40mm off the large flange on both sides of the panel at each end to allow it to fit into the channel as shown in Fig. 2.
  - 4 If a full-size framed fence extension (which is 2455mm long) will not fit into the available space, you will need to reduce its length. Ensure the frame (channel) is reduced by the same amount.

- Installation**
- 1 Slide the long channel over the narrow flange of the fence extension panel as per Fig. 2,
  - 2 Fit the plastic corners into one end of each short channel and then fit the two short channels onto the ends of the long channel as per Fig. 3.
  - 3 Drill 4mm holes through the channels and corners and then screw or pop rivet the channels to the corners as per Fig. 3. Please ensure that screws do not interfere with the fence extension panel by fitting them off to one side of the channel.
  - 4 Mark at least two mounting points on each of the vertical channels.
  - 5 Drill 4mm holes right through the vertical channels at the marked mounting points as per Fig. 4.
  - 6 Drill 9mm clearance holes for the heads of the screws THROUGH THE FRONT SURFACE ONLY of the vertical channels as shown in Fig. 5.
  - 7 With the assistance of a second person, raise that assembled fence extension into position on the fence and screw it onto the fence as per Fig. 6, ensuring that both vertical channels are square to the horizontal channel using a corner of the cardboard box or a set square.
 

NOTE: Spacers (not supplied) may need to be fitted between the vertical channels and the fence to ensure that the fence extension is vertical (e.g. if a capping is fitted to the fence).
  - 8 Cover the 9mm clearance holes with the supplied screw hole caps as per Fig. 7.
  - 9 Attach the bracket to the flange at the centre of the panel to ensure that the panel does not bow or move in the wind as per Fig. 8.

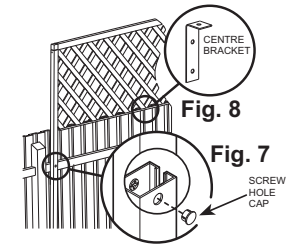
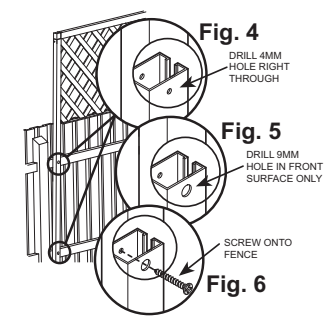
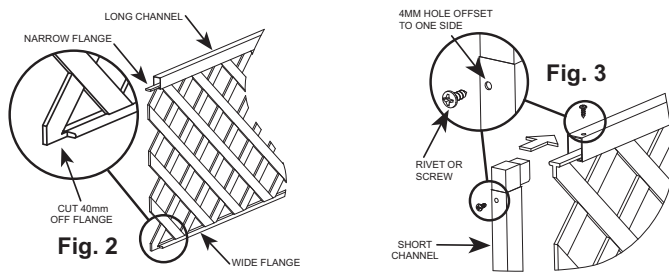
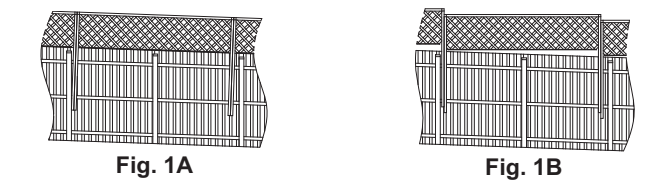

- Specifications**
- Lattice panel nominal dimensions 2430mm x 1215mm  
 Fence Extension panel nominal dimensions 2430mm x 530mm
- EcoScreen® must be installed in a way that allows it to freely expand and contract due to changes in temperature.
  - EcoScreen® must not be used where substantial weight is to be placed on it (such as for flooring).
  - Extra support must be provided wherever EcoScreen® is used in non-vertical applications.
  - Refer to applicable regulations before using EcoScreen® in a safety fence (such as around a pool or spa).
- Optional Mounting Kits**
1. HandyFrame mounting kit consists of a BHP COLORBOND® steel frame, plastic corners and screw caps. COLORBOND® is a registered trademark of BHP Steel (JLA) Pty Ltd.
  2. Quick Cap mounting kit consists of plastic washers with caps in matching colours for surface mounting to any support structure.
  3. Fence Extension Frame Kit consists of BHP COLORBOND® steel uprights and top channel, plastic corners & screw hole caps.

- Questions & Answers**
- Can EcoScreen® lattice be painted?**  
 Painting is not recommended as the paint will peel after a varying period of time.
- Can EcoScreen® lattice be curved?**  
 EcoScreen® lattice can be curved to around 300mm in diameter.
- How can EcoScreen® lattice be cut?**  
 Using any wood saw, jig saw, etc. you can cut EcoScreen® lattice with ease. Can also be drilled.

**WARRANTY**

EcoScreen® range of products has been designed to enhance your home or garden and to provide many years of maintenance free use when installed correctly.

Viscount Plastics (Vic) Pty Ltd (Viscount) warrants to the original purchaser that the EcoScreen® range of products will be free of structural faults due to defects in materials or manufacturing for 15 years from the date of purchase.

This warranty does not cover the colour of the EcoScreen® range of products. Although the materials used to produce the EcoScreen® range are designed to resist fading, the colour may change over time.

This warranty is only valid if the instructions for installation and care are correctly followed.

All warranty claims must be directed to the place of purchase.

If a warranty claim is accepted by Viscount, Viscount will at its election repair the faulty product, or replace the faulty product and deliver it free of charge to the point of purchase within a capital city, or authorise the refund of the purchase price. Warranties and remedies, including compensation for consequential or indirect losses, other than those set out above are hereby excluded except to the extent where to so exclude would contravene any law (including the Trade Practices Act (Cth) 1974) or cause any part of this warranty to be void.

## Lifetime Decorative Plastic Lattice

...for any scene

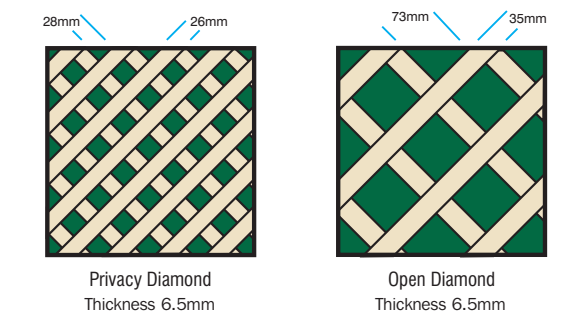

Available in a range of colours in both sheet and fence extension panels.

Uses: Carport, pergola & gazebo infill panels, veranda's, service enclosures, balustrades & fence extensions.

- Privacy Diamond available in:
- Smooth Cream
  - Caulfield Green
  - Slate Grey
  - Stone
  - Heritage Red
  - Mountain Blue
  - Wheat
  - Merino
  - Mist Green
  - Rivergum Green
  - Off White
- Open Diamond, available in:
- Smooth Cream
  - Caulfield Green

These colours should be used as a guideline only as product colours may vary.

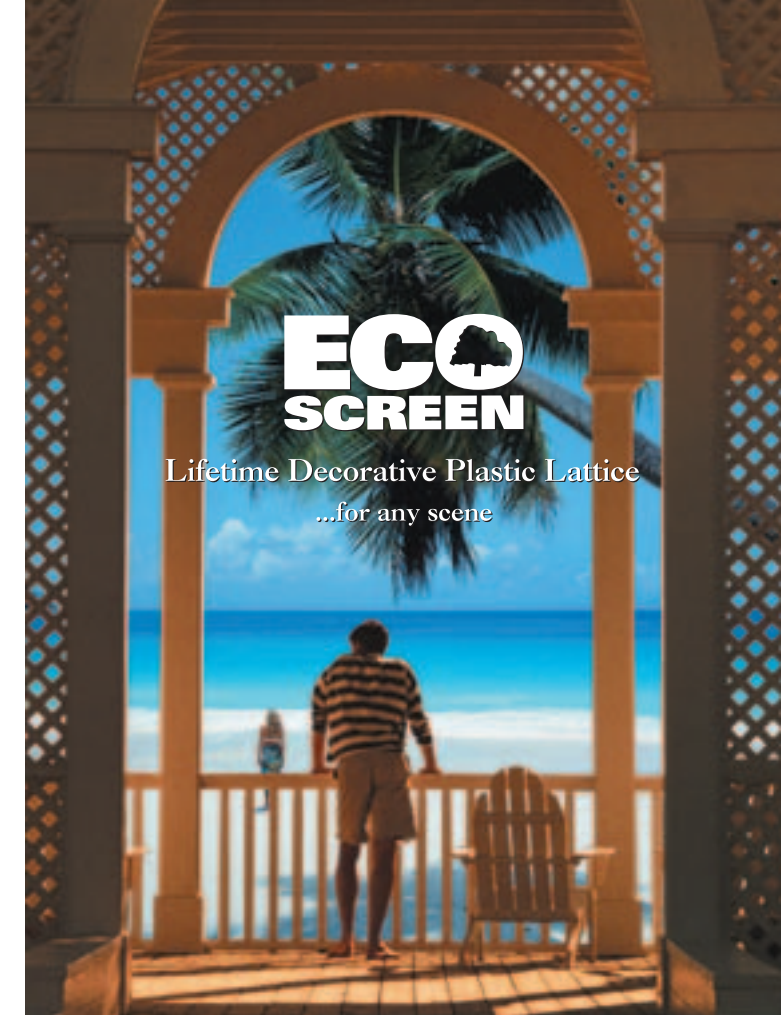

**EcoScreen**

Lifetime Decorative Plastic Lattice

...for any scene

- UV Stable
- Will never rot, rust or come apart
- Will never need painting
- Fade and mildew resistant
- Maintenance free
- Termite Proof
- Non-toxic
- Can be easily cut and shaped

**NOTE:** Before inserting screws through the lattice sheet, first drill a hole 12mm in diameter. Use a screw (and washer) with a thread diameter of 4mm to allow for expansion and contraction. Ensure that each lattice sheet has a gap of at least 8mm for expansion on all sides. Wherever two lattice sheets butt up, you must therefore leave a 16mm gap. Failure to do this may invalidate the warranty.

EcoScreen® Plastic Lattice comes with a 15 year structural warranty



# lifetime decorative plastic lattice

EcoScreen® Lattice is perfect for privacy, shade or decoration and will enhance any home or garden.

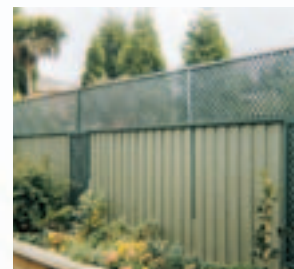
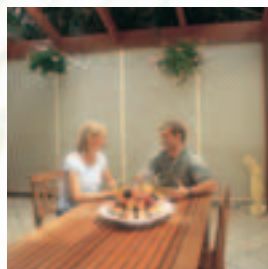

EcoScreen® allows you to create beautiful features around your home, garden or courtyard, simply and economically.

EcoScreen® combines deep timber texture and warm rich colours with unique features of toughness and flexibility.

EcoScreen® panels can be curved to follow a garden contour and can be easily cut to create that special shape or design.

You can capitalise on the quality, consistency, versatility and long-term durability of EcoScreen® lattice.

EcoScreen® panels are produced in one piece and are guaranteed to give many years of maintenance-free enjoyment.

## Lattice Sheet Installation

Once installed correctly, EcoScreen® will not require any ongoing maintenance for the life of the product.

Attaching EcoScreen® lattice panels to any support structure can be achieved easily with one of the following systems:

1. Quick Cap is a fast simple system that allows you to attach EcoScreen® using a series of washers, screws and caps.

2. HandyFrame system allows EcoScreen® panels to be surrounded with frames made from BHP COLORBOND® steel.

Frames are available in complementing or contrasting colours, are pre cut and ready to assemble.

## Fence Extensions

For additional privacy and style, EcoScreen® Fence Extensions can be easily fitted to a boundary fence.

All EcoScreen® designs are available in fence extensions.

Mounting and Frame kits are available in matching or contrasting colours.



Privacy Diamond

## Privacy Diamond

With its close slat spacing and small openings, this design will provide a superior level of privacy while complementing your home or garden. It is also excellent for providing shade against the intense summer sun.



Open Diamond

## Open Diamond

This model is particularly versatile with its many uses around the garden. The large openings and smooth edges of this design allow climbing plants to grow naturally through it. Unlike timber lattice, EcoScreen® will not come apart or deteriorate due to chemicals or repeated watering.



## option 1

### Fixing with a Frame Kit (sold separately)

#### Tools

Tape measure  
Marker pen  
Power or battery drill  
9mm drill bit for screw hole caps  
4mm drill bit to suit the thread of the screws  
Screwdriver  
Hacksaw\*  
Wood saw\*

\*Only required when reducing the length of the frame channels and the size of the lattice sheets.

#### Mounting Kit contents: (sold separately)

Two (2) 2382mm channels  
Two (2) 1175mm channels  
Four (4) corner joiners  
Eleven (11) push-on slide clips  
Sixteen (16) screw hole caps

**Note: Screws are not supplied**, you will need to purchase appropriate screws to suit the material to which you are attaching the lattice. Use the screw with a maximum head diameter of 9mm.

#### Preparation

- 1 Ensure that the support structure on which you are mounting the lattice is braced and all joints are secure.
- 2 If the surface of the structure is not flat, fit spacers to it at frame mounting points.
- 3 Clear an area on which to lay the lattice during assembly of the frame.
- 4 Measure the space available for installation of the framed lattice sheet. If the available space is smaller than 2455mm x 1245mm, reduce the size of the sheet and the frame to fit by cutting with a saw.

Note: The frame channels are pre-cut to ensure that the lattice sheet has room for expansion and contraction. **When reducing the size of the sheet ensure the frames (channels) are reduced by the same amount.**

#### Installation

- 1 Fit the push-on slide clips ONLY to BOTH SIDE and TOP of each lattice sheet approximately 500mm apart. Do not fit slide clips to the bottom edge of the lattice or closer than 100mm to a corner.
- 2 Once all the slide clips are fitted, slide the channel along the top edge of the lattice, ensuring that all slide clips are captured within the channel.
- 3 Slide the side channels up to the top corners, ensuring that all slide clips are captured within the channel.
- 4 Fit the corners to the bottom channel. Fit bottom channel to frame to complete assembly.
- 5 Lift the framed lattice and place in position on the supporting structure. Fasten the frame to the supporting structure through the hole in the corners. Two people will be required to do this as the frame lattice is heavy.
- 6 Fasten with appropriate screws against the rear surface of the channels only. Fit the hole caps to finish installation.

Note: To increase the life of your frame, we recommend drilling a minimum of 3 holes to allow water to drain out of the bottom channel.

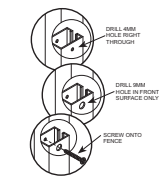
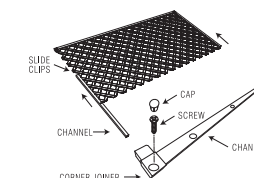
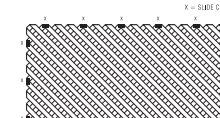
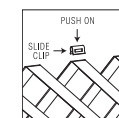

## option 2

### Fixing with a Quick Cap Mounting Kit

#### Tools

Tape measure  
Marker pen  
Power or battery drill  
12mm drill bit  
Screwdriver  
Wood saw\*

\*Only required when reducing the size of the sheet.

#### Mounting Kit contents: (sold separately)

Sixteen (16) plastic washers  
Sixteen (16) washer caps  
Drilling instructions

**Note: Screws are not supplied**, you will need to purchase appropriate screws to suit the material to which you are attaching the lattice sheet. Use countersunk head screws with a maximum head diameter of 9mm and a thread diameter of 4mm.

#### Preparation

- 1 Ensure that the support structure on which you are mounting the lattice is braced and all joints are secure.
- 2 The surface of the support structure should be flat, otherwise lattice will distort. Fit spacers under the mounting points if required.
- 3 Measure the space available for installation of the lattice sheet. If the available space is smaller than 2450mm x 1230mm, reduce the size of the sheet to fit by cutting with a saw.

**Note: Ensure that each lattice sheet has a gap of at least 8mm for expansion on all sides. Wherever two lattice sheets butt up, you must therefore leave a 16mm gap. Failure to do this may invalidate the warranty.**

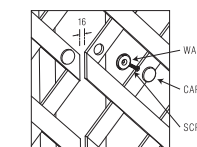
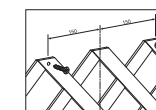

#### Installation

- 1 Mount the lattice sheet to the support structure using 2 screws at the top edge of the lattice about 150mm apart in the centre of the sheet.
- 2 Make the other 13 mounting points on the lattice approximately 500mm apart.
- 3 At each marked point drill a 12mm hole through the lattice sheet. Failure to use the correct size bit or drilling too close to an edge may void the warranty.
- 4 Put each screw through the hole in the washer so that the countersunk head fits into the recess, which will allow the cap to fit over the washer.
- 5 Once the screws are correctly fitted, fit washer caps to finish the installation.

**NOTE: Before inserting screws, drill a 12mm hole through the lattice sheet at each mounting point. This is to allow for expansion and contraction.**

**Note: If the lattice distorts once installed, release the screw tension or increase the clearance around the screws.**

## frame kit assembly

### Overall Dimensions

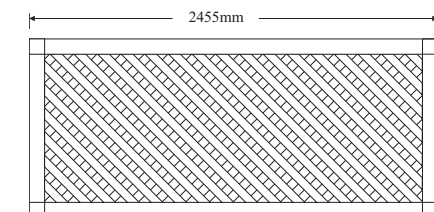

Lifetime Decorative Plastic Lattice  
...for any scene